

Product title:

RECTANGULAR SECTION RINGS FOR HOLES

M23LE7786

Product image:

Product price:

€9.00

Product short description:

RECTANGULAR SECTION RINGS FOR HOLES
M23LE7786

Product features:

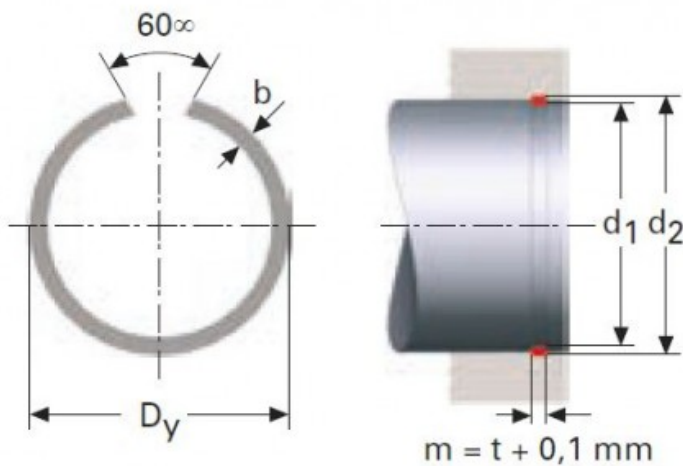
WIDTH (t): 1.5
OUTSIDE DIAMETER (Dy): 43.8
SHAFT DIAMETER (d1): 42
WIDE (b): 2.3
HOLE GROOVE DIAMETER (d2): 43.2

Product description:

RECTANGULAR SECTION RINGS FOR HOLES RSB

The rectangular cross-section of these retaining rings allows.

for higher loads than the round wire alternatives.

All dimensions are in mm.

Raw material steel CK 67.

Phosphated & slightly oiled.