

Product title:

# RECTANGULAR SECTION RINGS FOR HOLES

## M23LE7769

Product image:

Product price:

**€4.44**

Product short description:

RECTANGULAR SECTION RINGS FOR HOLES  
M23LE7769

Product features:

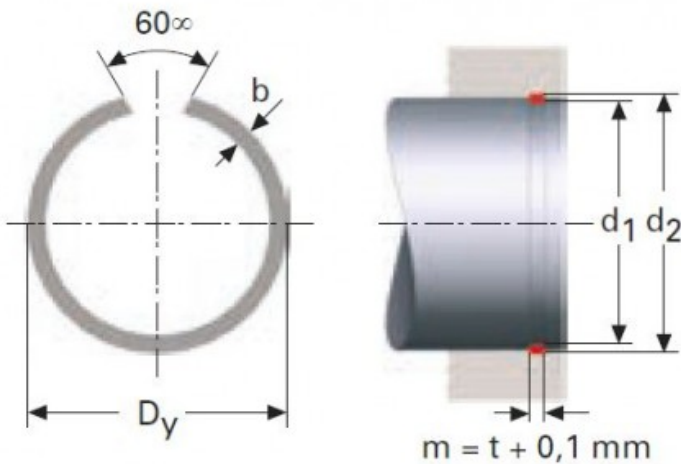
WIDTH (t): 0.8  
OUTSIDE DIAMETER (Dy): 10.6  
SHAFT DIAMETER (d1): 10  
WIDE (b): 1.2  
HOLE GROOVE DIAMETER (d2): 10.4

Product description:

RECTANGULAR SECTION RINGS FOR HOLES RSB

The rectangular cross-section of these retaining rings allows.

for higher loads than the round wire alternatives.

All dimensions are in mm.

Raw material steel CK 67.

Phosphated &amp; slightly oiled.