

Product title:

CLOCK SPRING M20LE938

Product image:

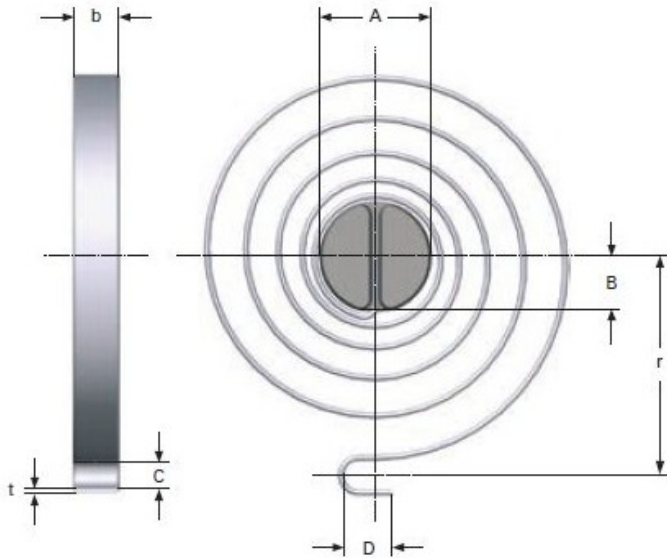

Product price:

€430.00

Product short description:

CLOCK SPRING

Product features:

TOTAL COILS: 8
RAW MATERIAL THICKNESS: 3
BAND WIDTH: 18
SHAFT DIAMETER: 32
LEG LENGTH: 12
TAIL WIDTH: 12.5
CENTER RADIO SPRING UNTIL FIXATION: 90
LONG TAIL HITCH: 18
RATE PER DEGREE OF TORQUE: 62.8
MAXIMUM TORQUE Nmm (10000): 36450
100000 CYCLES MAX. AT TORQUE ANGLE: 465
MAXIMUM TORQUE Nmm (100000): 29160
10038 CICLOS MAX. EN ANGULO DE TORSION: 581

Product description:

Clock springs made of stainless material according to EN 10270-3-1.4310

rounded edges to improve fatigue.

All dimensions are in mm