

Product title:

# CLOCK SPRING M20LE931

Product image:

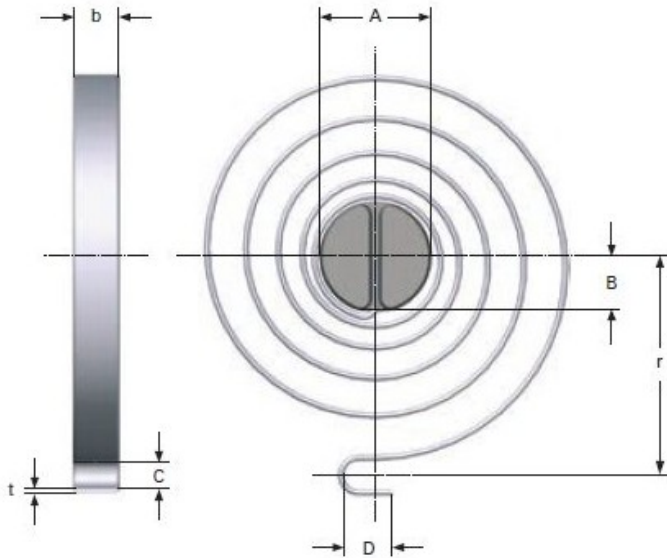

Product price:

**€172.00**

Product short description:

CLOCK SPRING

Product features:

TOTAL COILS: 8  
RAW MATERIAL THICKNESS: 2  
BAND WIDTH: 20  
SHAFT DIAMETER: 24  
LEG LENGTH: 8  
TAIL WIDTH: 8.4  
CENTER RADIO SPRING UNTIL FIXATION: 68  
LONG TAIL HITCH: 12  
RATE PER DEGREE OF TORQUE: 28.2  
MAXIMUM TORQUE Nmm (10000): 18667  
100000 CYCLES MAX. AT TORQUE ANGLE: 530  
MAXIMUM TORQUE Nmm (100000): 14933  
10031 CICLOS MAX. EN ANGULO DE TORSION: 663

Product description:

Clock springs made of stainless material according to EN 10270-3-1.4310

rounded edges to improve fatigue.

All dimensions are in mm