

Product title:

# CLOCK SPRING M20LE928

Product image:

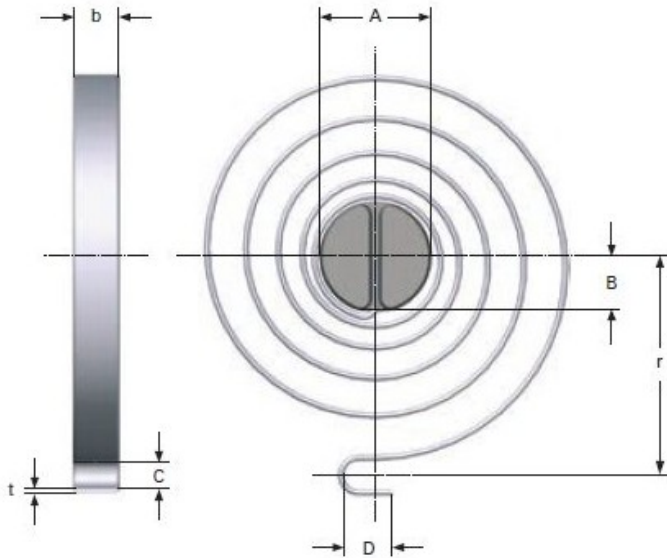

Product price:

**€98.00**

Product short description:

CLOCK SPRING

Product features:

TOTAL COILS: 5  
RAW MATERIAL THICKNESS: 2  
BAND WIDTH: 12  
SHAFT DIAMETER: 24  
LEG LENGTH: 8  
TAIL WIDTH: 8.4  
CENTER RADIO SPRING UNTIL FIXATION: 43  
LONG TAIL HITCH: 12  
RATE PER DEGREE OF TORQUE: 35.9  
MAXIMUM TORQUE Nmm (10000): 11200  
100000 CYCLES MAX. AT TORQUE ANGLE: 250  
MAXIMUM TORQUE Nmm (100000): 8960  
10028 CICLOS MAX. EN ANGULO DE TORSION: 312

Product description:

Clock springs made of stainless material according to EN 10270-3-1.4310

rounded edges to improve fatigue.

All dimensions are in mm