

Product title:

CLOCK SPRING M20LE925

Product image:

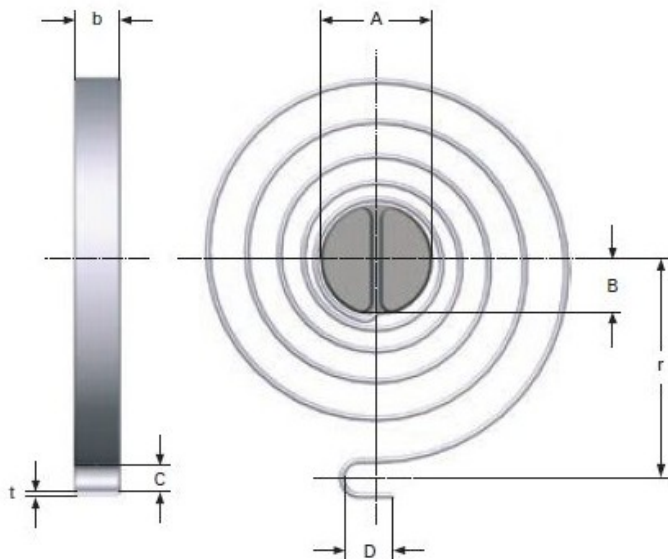

Product price:

€64.00

Product short description:

CLOCK SPRING

Product features:

TOTAL COILS: 5
RAW MATERIAL THICKNESS: 1.5
BAND WIDTH: 15
SHAFT DIAMETER: 20
LEG LENGTH: 7
TAIL WIDTH: 6.3
CENTER RADIO SPRING UNTIL FIXATION: 33
LONG TAIL HITCH: 9
RATE PER DEGREE OF TORQUE: 24.1
MAXIMUM TORQUE Nmm (10000): 8100
100000 CYCLES MAX. AT TORQUE ANGLE: 269
MAXIMUM TORQUE Nmm (100000): 6480
10025 CICLOS MAX. EN ANGULO DE TORSION: 336

Product description:

Clock springs made of stainless material according to EN 10270-3-1.4310

rounded edges to improve fatigue.

All dimensions are in mm