

Product title:

# CLOCK SPRING M20LE921

Product image:

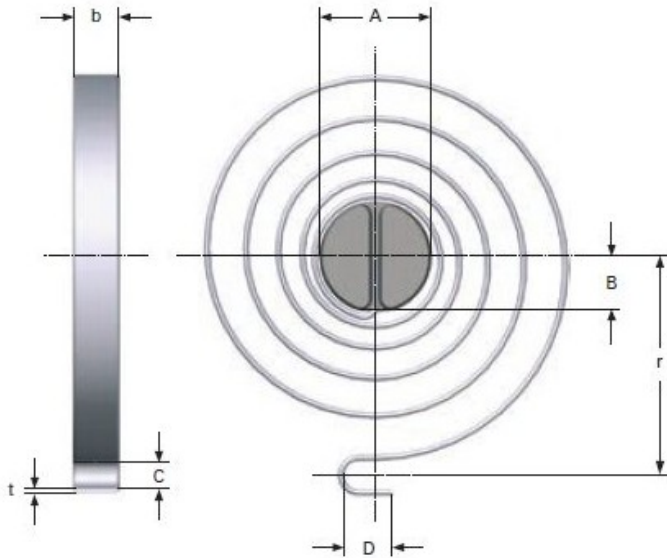

Product price:

**€54.00**

Product short description:

CLOCK SPRING

Product features:

TOTAL COILS: 5  
RAW MATERIAL THICKNESS: 1.25  
BAND WIDTH: 12  
SHAFT DIAMETER: 16  
LEG LENGTH: 6  
TAIL WIDTH: 6.3  
CENTER RADIO SPRING UNTIL FIXATION: 28  
LONG TAIL HITCH: 9  
RATE PER DEGREE OF TORQUE: 13.2  
MAXIMUM TORQUE Nmm (10000): 4500  
100000 CYCLES MAX. AT TORQUE ANGLE: 272  
MAXIMUM TORQUE Nmm (100000): 3600  
10021 CICLOS MAX. EN ANGULO DE TORSION: 340

Product description:

Clock springs made of stainless material according to EN 10270-3-1.4310

rounded edges to improve fatigue.

All dimensions are in mm