

Product title:

CLOCK SPRING M20LE920

Product image:

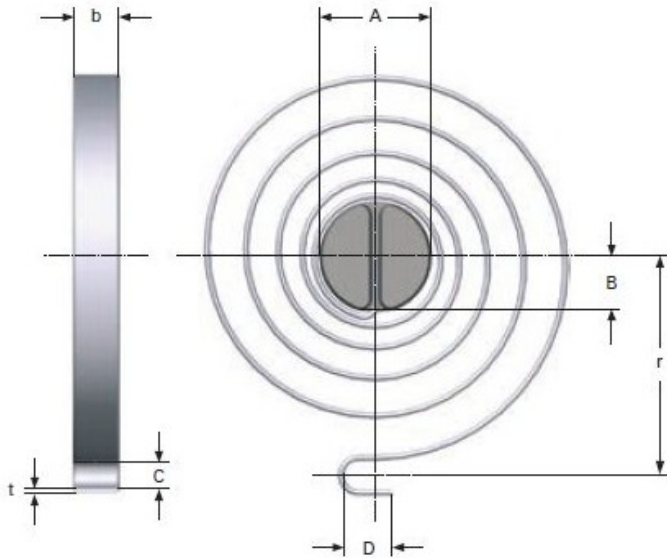

Product price:

€50.00

Product short description:

CLOCK SPRING

Product features:

TOTAL COILS: 5
RAW MATERIAL THICKNESS: 1.25
BAND WIDTH: 7
SHAFT DIAMETER: 16
LEG LENGTH: 6
TAIL WIDTH: 6.3
CENTER RADIO SPRING UNTIL FIXATION: 28
LONG TAIL HITCH: 9
RATE PER DEGREE OF TORQUE: 7.71
MAXIMUM TORQUE Nmm (10000): 2625
100000 CYCLES MAX. AT TORQUE ANGLE: 272
MAXIMUM TORQUE Nmm (100000): 2100
10020 CICLOS MAX. EN ANGULO DE TORSION: 340

Product description:

Clock springs made of stainless material according to EN 10270-3-1.4310

rounded edges to improve fatigue.

All dimensions are in mm