

Product title:

CLOCK SPRING M20LE918

Product image:

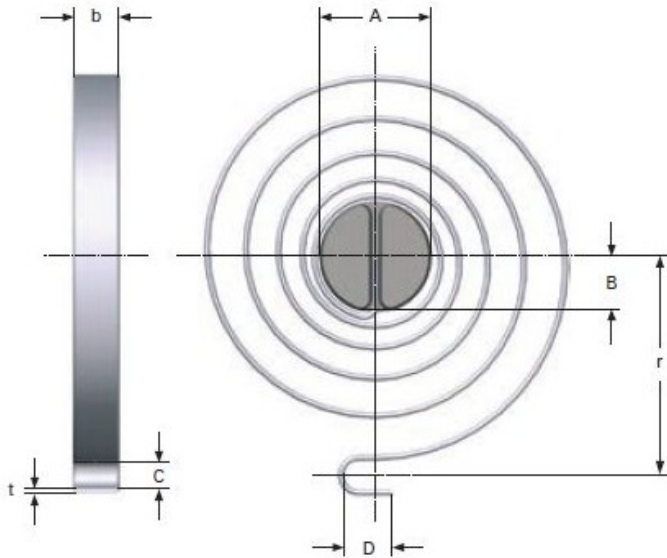

Product price:

€58.00

Product short description:

CLOCK SPRING

Product features:

TOTAL COILS: 8
RAW MATERIAL THICKNESS: 1
BAND WIDTH: 6
SHAFT DIAMETER: 14
LEG LENGTH: 5
TAIL WIDTH: 5.2
CENTER RADIO SPRING UNTIL FIXATION: 40
LONG TAIL HITCH: 7
RATE PER DEGREE OF TORQUE: 1.86
MAXIMUM TORQUE Nmm (10000): 1500
100000 CYCLES MAX. AT TORQUE ANGLE: 644
MAXIMUM TORQUE Nmm (100000): 1200
10018 CICLOS MAX. EN ANGULO DE TORSION: 805

Product description:

Clock springs made of stainless material according to EN 10270-3-1.4310

rounded edges to improve fatigue.

All dimensions are in mm