

Product title:

# CLOCK SPRING M20LE917

Product image:

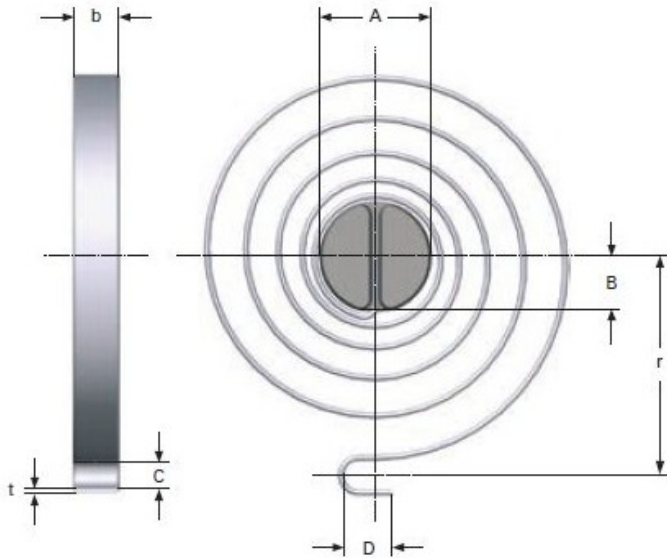

Product price:

**€44.00**

Product short description:

CLOCK SPRING

Product features:

TOTAL COILS: 5  
RAW MATERIAL THICKNESS: 1  
BAND WIDTH: 10  
SHAFT DIAMETER: 14  
LEG LENGTH: 5  
TAIL WIDTH: 5.2  
CENTER RADIO SPRING UNTIL FIXATION: 25  
LONG TAIL HITCH: 7  
RATE PER DEGREE OF TORQUE: 6.66  
MAXIMUM TORQUE Nmm (10000): 2500  
100000 CYCLES MAX. AT TORQUE ANGLE: 300  
MAXIMUM TORQUE Nmm (100000): 2000  
10017 CICLOS MAX. EN ANGULO DE TORSION: 375

Product description:

Clock springs made of stainless material according to EN 10270-3-1.4310

rounded edges to improve fatigue.

All dimensions are in mm