

Product title:

CLOCK SPRING M20LE912

Product image:

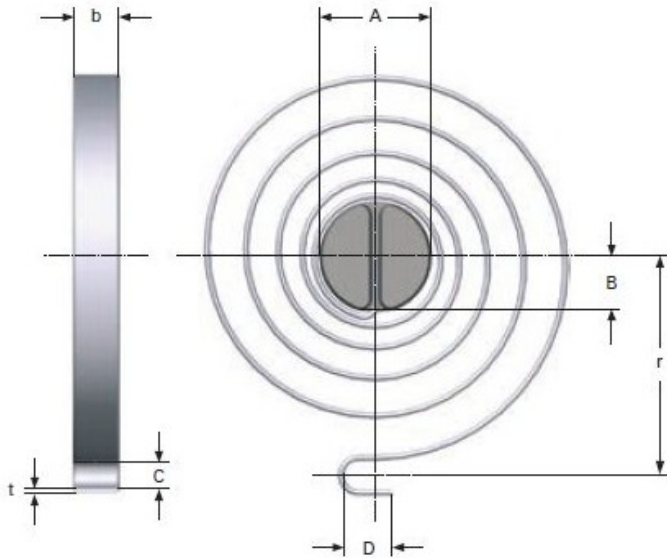

Product price:

€32.00

Product short description:

CLOCK SPRING

Product features:

TOTAL COILS: 5
RAW MATERIAL THICKNESS: 0.8
BAND WIDTH: 5
SHAFT DIAMETER: 12
LEG LENGTH: 4.5
TAIL WIDTH: 4.2
CENTER RADIO SPRING UNTIL FIXATION: 21
LONG TAIL HITCH: 6
RATE PER DEGREE OF TORQUE: 1.79
MAXIMUM TORQUE Nmm (10000): 816
100000 CYCLES MAX. AT TORQUE ANGLE: 364
MAXIMUM TORQUE Nmm (100000): 653
10012 CICLOS MAX. EN ANGULO DE TORSION: 456

Product description:

Clock springs made of stainless material according to EN 10270-3-1.4310

rounded edges to improve fatigue.

All dimensions are in mm