

Product title:

MOTOR SPRING M16LE61730

Product image:

Product price:

€314.60

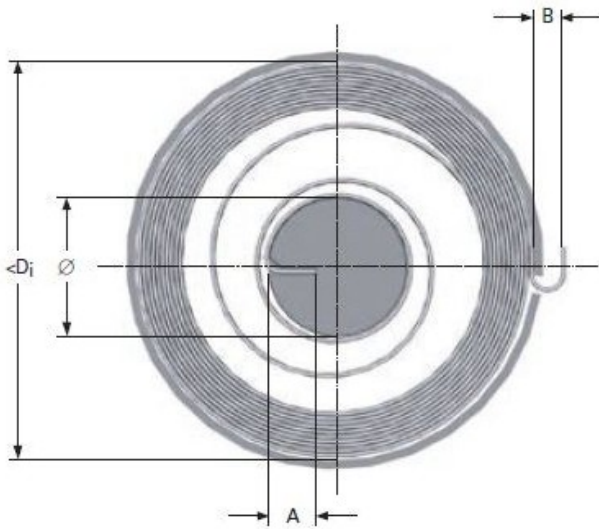

Product short description:

MOTOR SPRING M16LE61730

Product features:

INSIDE DIAMETER: 136
TOTAL COILS: 20
RAW MATERIAL THICKNESS: 0.47
BAND WIDTH: 20
SHAFT DIAMETER: 20
LEG LENGTH: 6
TORQUE: 500
MAXIMUM TORQUE: 1600
TAIL WIDTH: 6