

Product title:

# MOTOR SPRING M16LE61724

Product image:

Product price:

**€198.44**

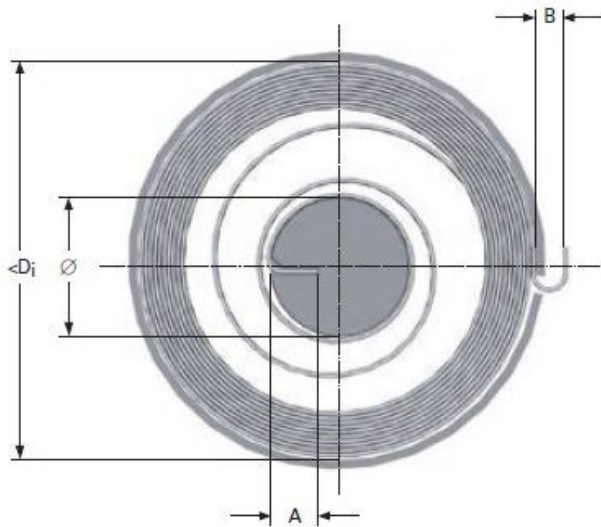

Product short description:

MOTOR SPRING M16LE61724

Product features:

INSIDE DIAMETER: 97  
TOTAL COILS: 20  
RAW MATERIAL THICKNESS: 0.34  
BAND WIDTH: 15  
SHAFT DIAMETER: 15  
LEG LENGTH: 4  
TORQUE: 210  
MAXIMUM TORQUE: 650  
TAIL WIDTH: 5