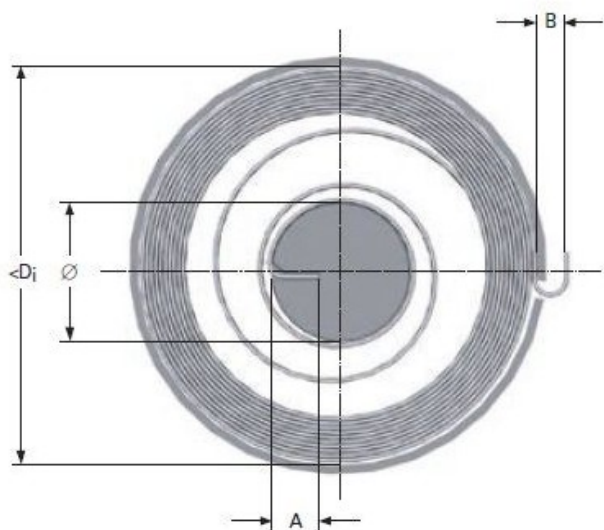

Product title:

MOTOR SPRING M16LE9451

Product image:

Product price:

€792.64

Product short description:

MOTOR SPRING M16LE9451

Product features:

INSIDE DIAMETER: 295
TOTAL COILS: 20
RAW MATERIAL THICKNESS: 1.5
BAND WIDTH: 20
SHAFT DIAMETER: 40
LEG LENGTH: 12
TORQUE: 1306
MAXIMUM TORQUE: 6713
TAIL WIDTH: 10