

Product title:

MOTOR SPRING M16LE8991

Product image:

Product price:

€193.70

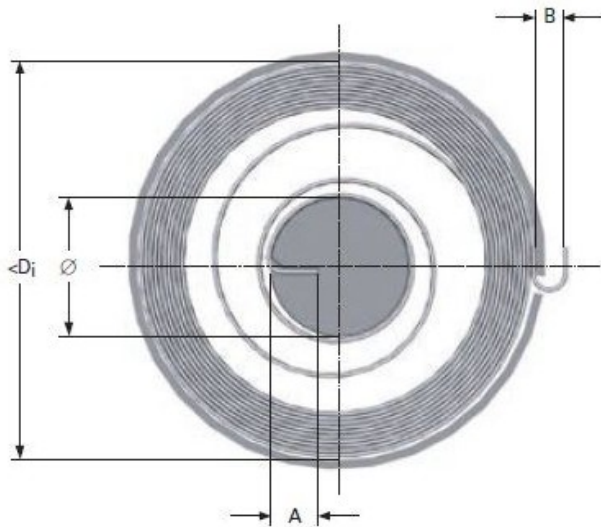

Product short description:

MOTOR SPRING M16LE8991

Product features:

INSIDE DIAMETER: 116
TOTAL COILS: 20
RAW MATERIAL THICKNESS: 0.6
BAND WIDTH: 15
SHAFT DIAMETER: 18
LEG LENGTH: 5
TORQUE: 192
MAXIMUM TORQUE: 891
TAIL WIDTH: 5