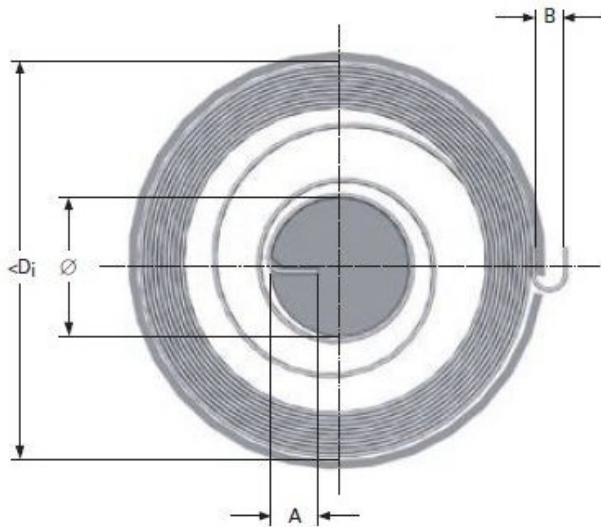

Product title:

MOTOR SPRING M16LE61719

Product image:

Product price:

€716.32

Product short description:

MOTOR SPRING M16LE61719

Product features:

INSIDE DIAMETER: 220
TOTAL COILS: 10
RAW MATERIAL THICKNESS: 0.98
BAND WIDTH: 30
SHAFT DIAMETER: 40
LEG LENGTH: 12
TORQUE: 3810
MAXIMUM TORQUE: 10140
TAIL WIDTH: 10