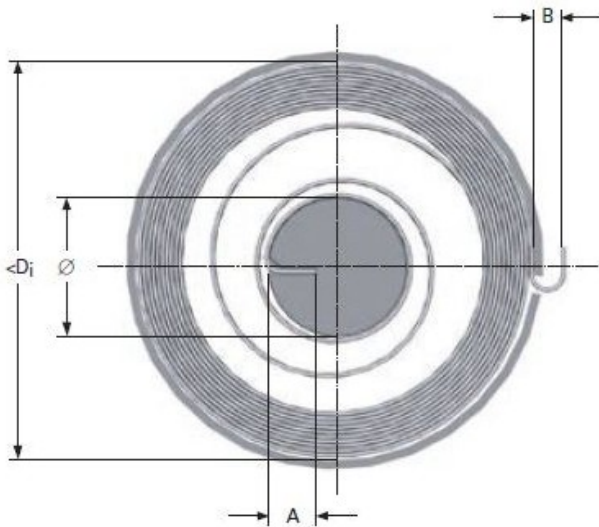

Product title:

MOTOR SPRING M16LE61718

Product image:

Product price:

€663.08

Product short description:

MOTOR SPRING M16LE61718

Product features:

INSIDE DIAMETER: 220
TOTAL COILS: 10
RAW MATERIAL THICKNESS: 0.98
BAND WIDTH: 25
SHAFT DIAMETER: 40
LEG LENGTH: 12
TORQUE: 3170
MAXIMUM TORQUE: 8450
TAIL WIDTH: 10