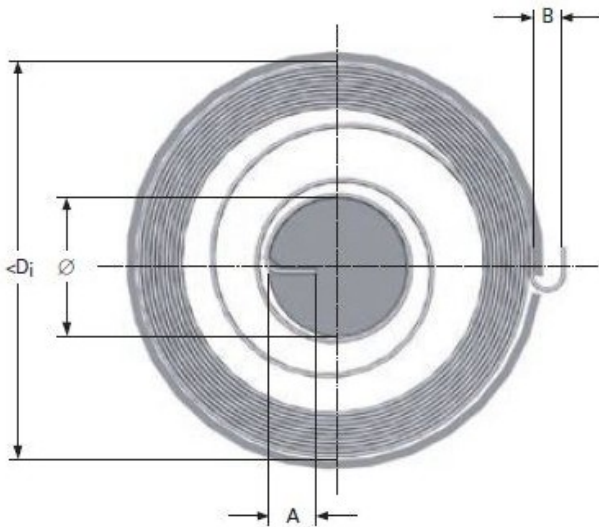

Product title:

MOTOR SPRING M16LE61716

Product image:

Product price:

€363.00

Product short description:

MOTOR SPRING M16LE61716

Product features:

INSIDE DIAMETER: 145
TOTAL COILS: 10
RAW MATERIAL THICKNESS: 0.66
BAND WIDTH: 25
SHAFT DIAMETER: 30
LEG LENGTH: 8
TORQUE: 1530
MAXIMUM TORQUE: 3920
TAIL WIDTH: 8