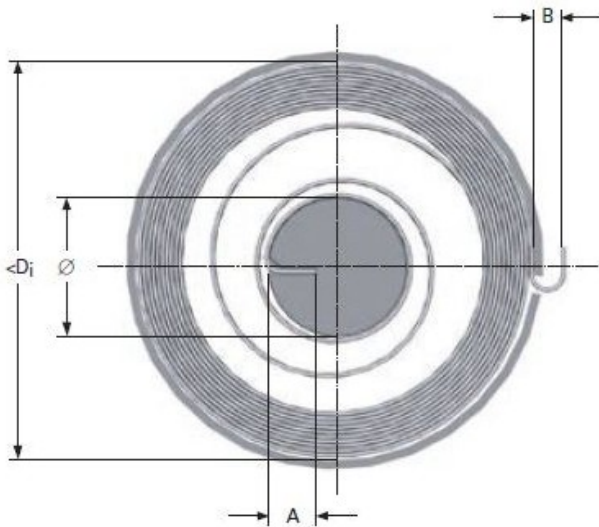

Product title:

MOTOR SPRING M16LE61715

Product image:

Product price:

€324.28

Product short description:

MOTOR SPRING M16LE61715

Product features:

INSIDE DIAMETER: 145
TOTAL COILS: 10
RAW MATERIAL THICKNESS: 0.66
BAND WIDTH: 20
SHAFT DIAMETER: 30
LEG LENGTH: 8
TORQUE: 1220
MAXIMUM TORQUE: 3130
TAIL WIDTH: 8