

Product title:

MOTOR SPRING M16LE61712

Product image:

Product price:

€222.64

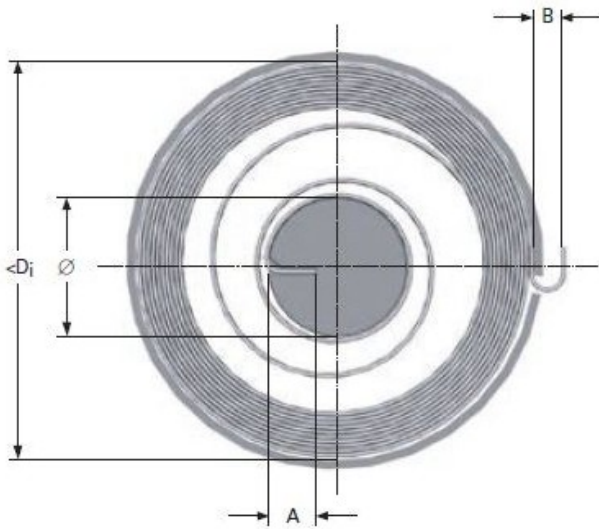

Product short description:

MOTOR SPRING M16LE61712

Product features:

INSIDE DIAMETER: 115
TOTAL COILS: 10
RAW MATERIAL THICKNESS: 0.56
BAND WIDTH: 15
SHAFT DIAMETER: 25
LEG LENGTH: 7
TORQUE: 600
MAXIMUM TORQUE: 1560
TAIL WIDTH: 6