

Product title:

MOTOR SPRING M16LE61710

Product image:

Product price:

€198.44

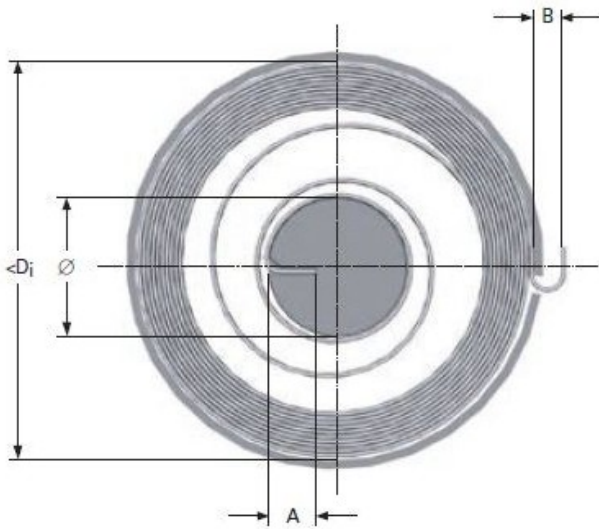

Product short description:

MOTOR SPRING M16LE61710

Product features:

INSIDE DIAMETER: 100
TOTAL COILS: 10
RAW MATERIAL THICKNESS: 0.47
BAND WIDTH: 20
SHAFT DIAMETER: 20
LEG LENGTH: 6
TORQUE: 600
MAXIMUM TORQUE: 1580
TAIL WIDTH: 6