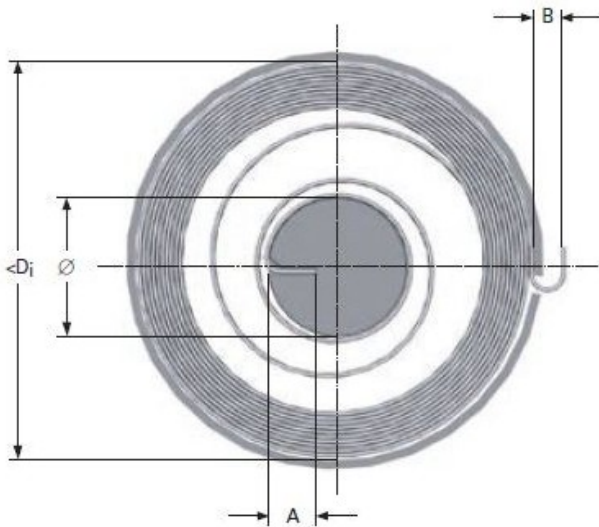

Product title:

MOTOR SPRING M16LE61706

Product image:

Product price:

€145.20

Product short description:

MOTOR SPRING M16LE61706

Product features:

INSIDE DIAMETER: 85
TOTAL COILS: 10
RAW MATERIAL THICKNESS: 0.4
BAND WIDTH: 12
SHAFT DIAMETER: 18
LEG LENGTH: 5
TORQUE: 280
MAXIMUM TORQUE: 710
TAIL WIDTH: 5