

Product title:

MOTOR SPRING M16LE61704

Product image:

Product price:

€125.84

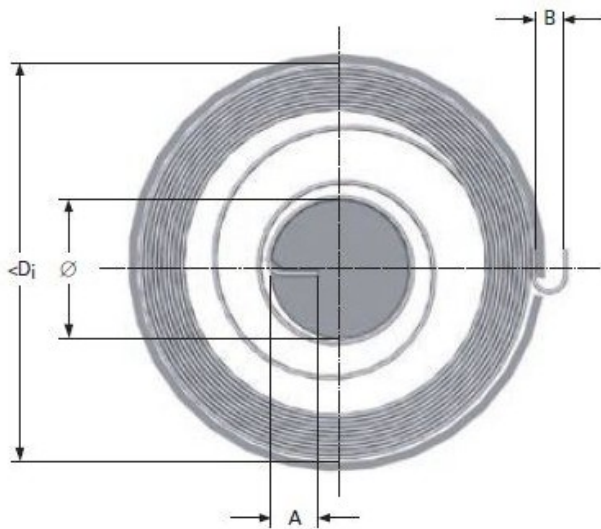

Product short description:

MOTOR SPRING M16LE61704

Product features:

INSIDE DIAMETER: 70
TOTAL COILS: 10
RAW MATERIAL THICKNESS: 0.34
BAND WIDTH: 15
SHAFT DIAMETER: 15
LEG LENGTH: 4
TORQUE: 240
MAXIMUM TORQUE: 630
TAIL WIDTH: 5