

Product title:

MOTOR SPRING M16LE61703

Product image:

Product price:

€121.00

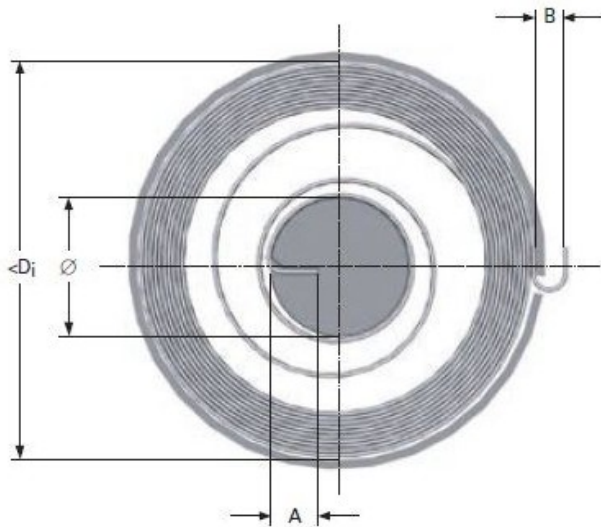

Product short description:

MOTOR SPRING M16LE61703

Product features:

INSIDE DIAMETER: 70
TOTAL COILS: 10
RAW MATERIAL THICKNESS: 0.34
BAND WIDTH: 12
SHAFT DIAMETER: 15
LEG LENGTH: 4
TORQUE: 190
MAXIMUM TORQUE: 500
TAIL WIDTH: 5