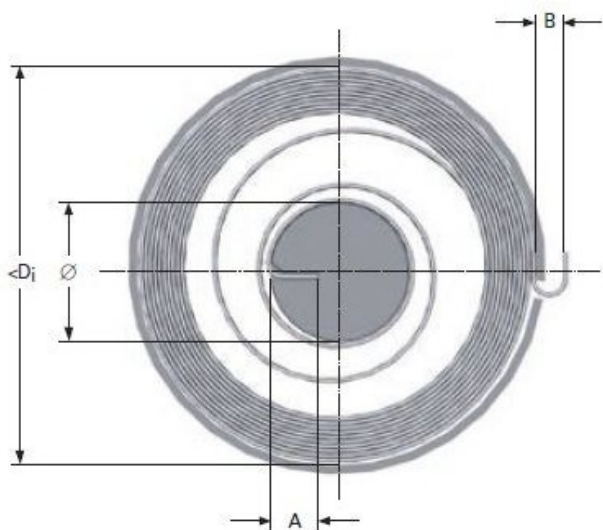

Product title:

MOTOR SPRING M16LE8982

Product image:

Product price:

€545.90

Product short description:

MOTOR SPRING M16LE8982

Product features:

INSIDE DIAMETER: 220
TOTAL COILS: 10
RAW MATERIAL THICKNESS: 1.5
BAND WIDTH: 25
SHAFT DIAMETER: 40
LEG LENGTH: 12
TORQUE: 2014
MAXIMUM TORQUE: 8457
TAIL WIDTH: 10