

Product title:

Double torsion spring according to DIN 2089

Product image:

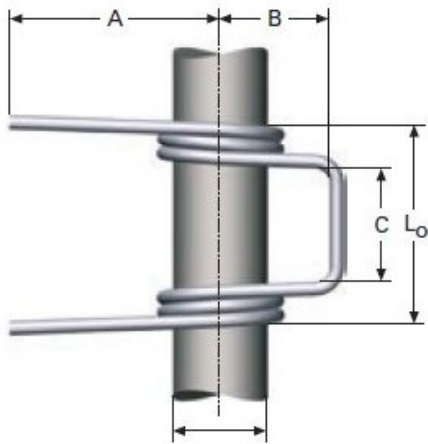

Product price:

€60.74

Product short description:

Muelle de doble torsion LEDT8597

Product features:

FREE ANGLE POSITION: A
SKU: LEDT8597
LENGTH LEGS: 80
SHAFT DIAMETER: 20
FRAME LENGTH: 30
FRAME WIDTH: 26
LENGTH BETWEEN LEGS: 50
INSIDE DIAMETER: 23
WIRE DIAMETER: 3
RAW MATERIAL: EN 10270-3 1.4310
COILS ON EACH BODY: 3
MAXIMUM PERMITTED TORQUE: 5828
TORQUE ANGLE AT MN (?): 53

Product description:

- Double torsion spring according to DIN 2089
- Brand name: LESJÖFORS Springs
- Raw material: Stainless steel;EN 10270-3-1.4310
- Cycles guarantee : Infinite if working without reaching yield point
- All measures are in N. and mm.

{tab Delivering time}

{article 8 days delivering time} {text} {/article}

{tab Technical information}

Coming soon

{tab Other informations}

{/tabs}